

# NPM-6 Series Transceivers

## Accessories

## Table of Contents

	Page No
Battery BL-4C .....	3
Product Code .....	3
Standard Charger ACP-7 .....	4
Product Codes .....	4
Specification .....	4
Travel Charger ACP-8 .....	5
Product Codes .....	5
Specification .....	6
Travel Charger ACP-12 .....	7
Product Codes .....	7
Specification .....	7
Mobile Charger LCH-9 .....	8
Product Code .....	8
Specification .....	8
Mobile Charger LCH-12 .....	9
Product Code .....	9
Specification .....	9
HS-5 Headset .....	10
Product Code .....	10
Headset HS-5 .....	10
Boom Headset HDB-4 .....	11
Product Code .....	11
Stereo Headset HDS-3 .....	12
Product Code .....	12
Inductive Loopset LPS-4 .....	13
Product Code .....	13
Camera Headset HS-1C .....	14
Product Code .....	14
Headrest Handsfree BHF-1 .....	15
Connectivity Adapter Cable DKU-5 .....	16
Product Code .....	16
Carrying Cases .....	17
Carrying Strap MBA-8 (Eur) .....	17
Product code .....	17
Xpress-On™ Shells .....	18

## Battery BL-4C

The BL-4C is a Li-ION type battery with a rating of 720mAh

### Product Code

Battery Pack BL-4C: *0670386 (Region: Eur/Apac)*

Battery Pack BL-4C: *0670387 (Region: France)*

Battery Pack BL-4C: *0670389 (Region: China)*

Figure 1: Battery BL-4C

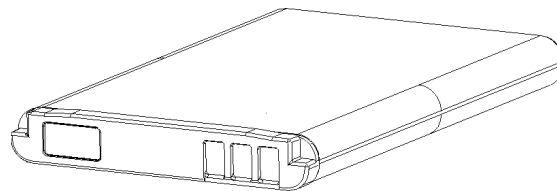

## Standard Charger ACP-7

The standard charger is available for different voltage levels and comes with different wall plugs. The standard charger can also be used as a power supply for the desktop stand.

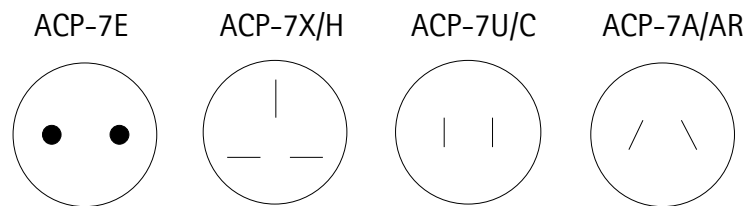
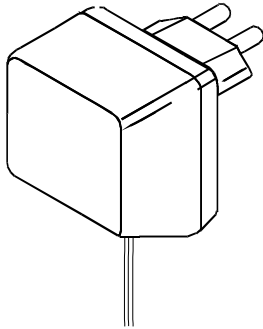

### Product Codes

Standard Charger (Eur) 230 Vac (Made in country)	ACP-7E	0675144
Standard Charger (Eur) 230 Vac (Made by manufacturer)	ACP-7E	0675171
Standard Travel Charger (US) 120 Vac (Made in country)	ACP-7U	0675143
Standard Travel Charger (US) 120 Vac (Made by manuf.)	ACP-7U	0675172
Standard Charger (UK) 230 Vac (Made in country)	ACP-7X	0675145
Standard Charger (UK) 230 Vac	ACP-7X	0675173
Standard Charger (Hong Kong) 200 Vac	ACP-7H	0675146
Standard Charger (China) 220 Vac	ACP-7C	0675212
Standard Charger (Philippines) 220 Vac	ACP-7C	0675158
Standard Charger (Australia) 240 Vac	ACP-7A	0675148
Standard Travel Charger (Argentina) 220 Vac	ACP-7AR	0675244

### Specification

Output Voltage  $7.6 \pm 0.35V$

## Travel Charger ACP-8

Operating within the voltage range 90 V...264 V AC (50 Hz...60 Hz), the Travel Charger is practically current independent in normal office and household use. Like the standard charger, it is compatible with all battery options and is available for different wall sockets.

The Travel Charger can also be used with desktop stand.

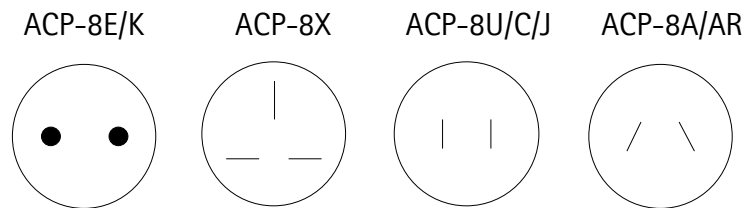
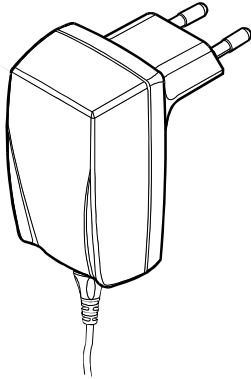

### Product Codes

ACP-8E	Travel Charger (Eur) 90-264 Vac	0675195
ACP-8U	Rapid Travel Charger (US) 90-264 Vac	0675196
ACP-8U	Travel Charger (US) 90-264 Vac (Made by manufacturer)	0675269
ACP-8X	Travel Charger (UK) 90-264 Vac	0675197
ACP-8J	Travel Charger	0675198
ACP-8K	Travel Charger	0675199
ACP-8A	Fast & Light Charger (Australia) 90-264 Vac	0675214
ACP-8C	Fast & Light Charger (China) 90-264 Vac	0675211
ACP-8UB	Travel Charger	0675236
ACP-8G	Travel Charger	0675237
ACP-8AR	Rapid Travel Charger (Argentina)	0675248

**Specification**

Output connectors: 3.5 mm DC plug, 2-pole (+, -, control)

Protection: Output fault voltage 16 V max.

Output voltage: 6.0 V (+0.3 V) / -0.7 V

## Travel Charger ACP-12

Operating within the voltage range 90 V...264 V AC (50 Hz...60 Hz), the Travel Charger is practically current independent in normal office and household use. Like the standard charger, it is compatible with all battery options and is available for different wall sockets.

The Travel Charger can also be used with desktop stand.

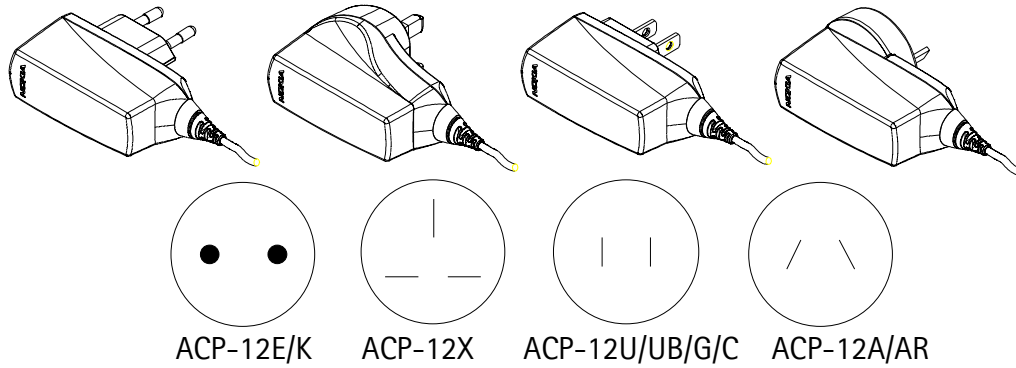

### Product Codes

ACP-12E	Travel Charger (Eur) 90-264 Vac	0675294
ACP-12X	Travel Charger	0675296
ACP-12U	Travel Charger	0675303
ACP-12UB	Travel Charger	0675293
ACP-12G	Travel Charger	0675295
ACP-12C	Travel Charger	0675297
ACP-12A	Travel Charger	0675300
ACP-12AR	Travel Charger	0675298

### Specification

Protection: *output current limiting, max. 850 mA*

*output voltage limiting, max. 9.3 V (unloaded)*

Output voltage/current (typ): *8.4 V / 800 mA*

## Mobile Charger LCH-9

A green light indicates that the cigarette mobile charger is ready for charging. Check the charging status on the phone display. The input voltage can be from 11 or 32 V d.c., negative grounding.

Universal mobile charger can be used with all car accessories provided for your phone except MCC-1

### Product Code

Mobile Charger LCH-9 (English type label): 0675120

Mobile Charger LCH-9 (Chinese type label): 0675239

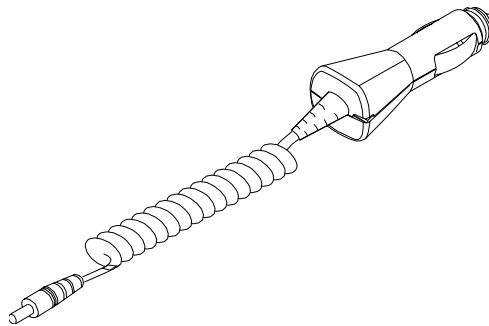

### Specification

#### Connectors

- input: D 21/23 mm
- output: 3.5 mm DC plug

Protection: *input fused, output current limit 850 mA*

#### Voltage

- input: 10.8 to 32 V DC
- output: 7.8 +/- 1 V

Nominal output current: 800 mA



## Mobile Charger LCH-12

A green light indicates that the cigarette mobile charger is ready for charging. Check the charging status on the phone display.

### Product Code

Mobile Charger LCH-12: 0675328

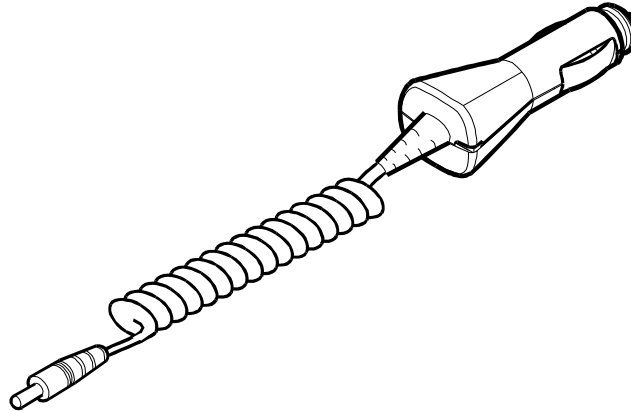

### Specification

#### Voltage

- input: 10.8 to 32 V DC
- output: 7.8 +/- 1 V

## HS-5 Headset

An easy and convenient handsfree solution with remote control.

### Product Code

Headset HS-5: (Eur/Apac)

0694121

Headset HS-5: ( na)

0694122



## Boom Headset HDB-4

The Nokia Boom Headset with basic HF functionality with send/end button is the portable personal handsfree configuration for your Nokia mobile phone.

### Product Code

Headset HDB-4: (Eus/Afri/Apac) 0694094

Headset HDB-4:(China) 0694108

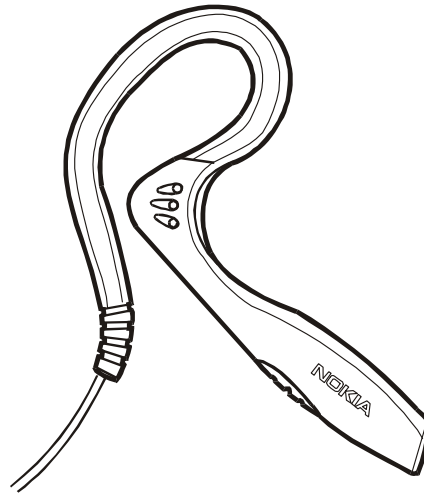

## Stereo Headset HDS-3

The Stereo Headset HDS-3 including remote control with microphone and answer/end button is the standard portable personal handsfree configuration for the Nokia 5100 mobile phone. FM radio connection between headset and mobile phone.



### Product Code

Stereo Headset HDS-3 (English label): 0694093

Stereo Headset HDS-3 (Chinese label): 0694109

## Inductive Loopset LPS-4

A convenient, easy-to-use portable loopset for users of T-coil-equipped hearing aids. It enables you to use a hearing aid together with your Nokia mobile phone.

### Product Code

Inductive Loopset LPS-4 (Eur/Afr and Apac type label): 0630443

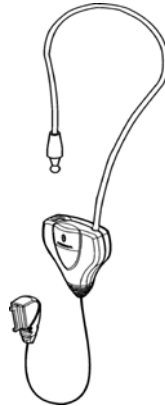

## Camera Headset HS-1C

Combination of digital camera and headset. Basic handsfree functionality. Small and lightweight.

### Product Code

Camera Headset HS-1C (Eur/Afr and Apac): *0694124*

Camera Headset HS-1C (China): *0694128*



## Headrest Handsfree BHF-1

Excellent audio quality. Installation in car's headrest. Easy to install. Charging the phone battery and powering up the terminal via LCH-9 or LCH-12.

### Product Code

Headrest Handsfree BHF-1 (Eur/Afr and Apac type label): 0694102

Headrest Handsfree BHF-1 (China): 0694131

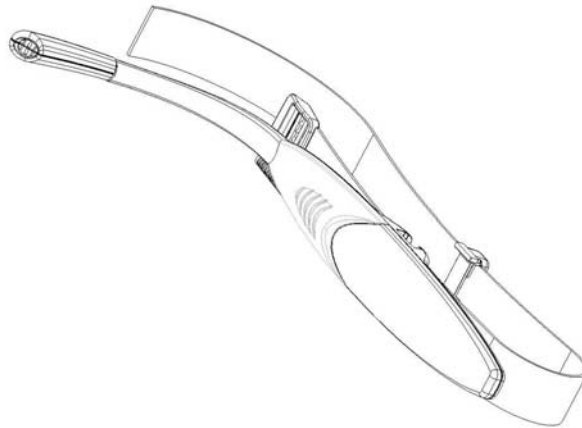

## Connectivity Adapter Cable DKU-5

Seamless connectivity between USB compatible PC and Nokia phone. Supports a Nokia PC Suite usage and synchronization desk stand. Enables data transfer and synchronization with PC.

### Product Code

Connectivity Adapter Cable DKU-5: *0730235*

Sales package code (Eur/Afr): *0273436*





## Carrying Cases

Fashionable carrying concepts designed for your Nokia phone.

### Carrying Strap MBA-8 (Eur)

For easy and convenient carrying and fastening of your Nokia 5100 phone.

#### Product code

Carrying strap MBA-8

0720341



## Xpress-On™ Shells

The unique Nokia Xpress-on™ shells let you change the shells of your Nokia 5100 in a unique way –you can change the top and bottom shells.

Blue SKR-337:(Eur/Afr)	0262919
Red SKR-338: (Eur/Afr/Apac)	0262920
Orange SKR-339:(Eur/Afr)	0262921
Dark Green SKR-340:(Eur/Afr)	0262922
Dark Grey SKR-343:(Apac)	0262993
Green SKR-344:(Apac)	0262994

## Choices





Orange  
SKR-339



Dark Green  
SKR-340



